



Brazo Aplicador:S-2/150

Inverter: SCHNEIDER

Sensores y fotocelulas:DATA SENSOR

Motor paso-paso B.P.

- Ancho max etiqueta width: 150 mm
- Motor paso paso desde 4 a 30 m/min.
- Alimentación 220 V - 50 Hz
- Cepillo para ajuste tensión etiqueta/transp.
- Soporte rollos int. 50 mm, exterior. 250 mm
- Soporte rollo siliconado con desbloqueo rápido.
- Fotocélula detección inicio (start).
- Ajuste fotocélula stop para fin etiqueta.
- Cabezal rotatable para etiquetado lateral.
- Velocidad ajustable por potenciómetro.
- Rodamientos SKF
- Alimentación: 230/380 V - 50/60 Hz

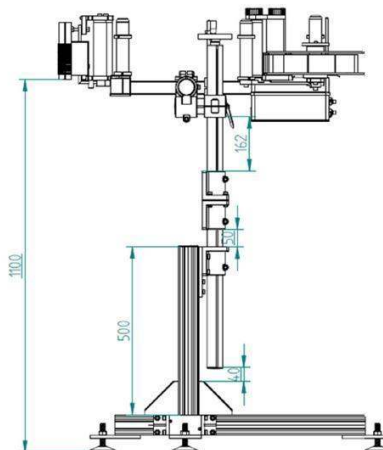
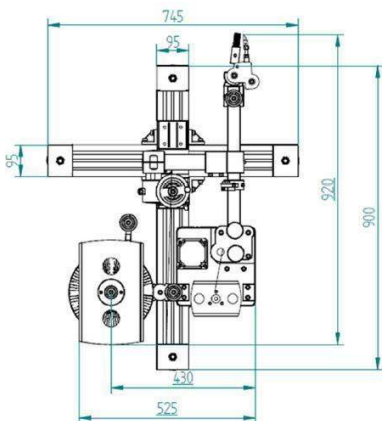

FORMULARIO PARA EQUIPO ETIQUETADO**CARACTERÍSTICAS DE APLICACION**

Aplicacion: Cara Abajo Arriba Otra

Velocidad: nr.pieces for minute / for hour

Descripcion del producto: Por favor señale la forma externa del product según el formulario de identificación en esquema (pagina 2) Si no aparece una forma similar incluya una foto del producto desde varias vistas.

Forma: redonda, Cuadrada, oval.....etc.

Material: Vidrio, plastico,etc.

Dimensiones: Longitud..... Ancho..... Altura.....
Diámetro.....

Contenido: lleno y cubierto Yes No

DESCRIPCION DE ETIQUETAS

Posicion de la etiqueta: Please señale la posicion externa de la etiqueta en el producto producto.

Material: papel, vinilo- transparente etc.....





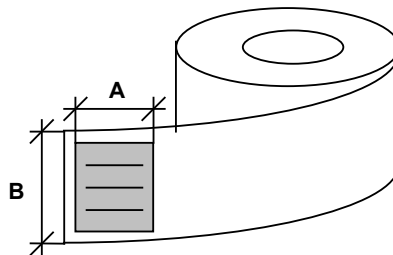





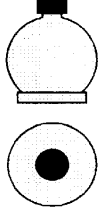
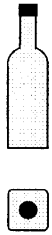
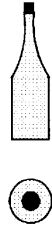



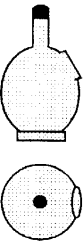
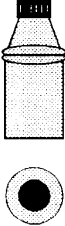
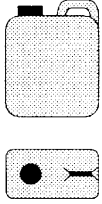
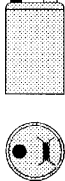
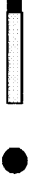
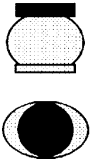
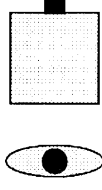
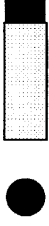
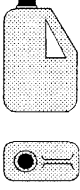





Posicion: frontal, detras, etc.....

Dimensions: a) longitud.....
b) altura.....

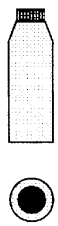

PRODUCTOS E IDENTIFICATION

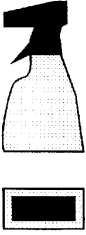
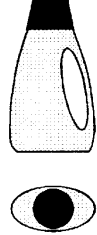
Please point out the number corresponding to your product and the position of the label

| | | | | | | | |
|---|---|---|---|---|---|--|---|
| 1  | 2  | 3  | 4  | 5  | 6  | 7  | 8  |
| 9  | 10  | 11  | 12  | 13  | 14  | 15  | 16  |
| 17  | 18  | 19  | 20  | 21  | 22  | 23  | 24  |
| 25  | 26  | 27  | 28  | 29  | 30  | 31  | 32  |
| 33  | 34 | 35 | 36 | 37 | 38 | 39 | 40 |

Otra.....